

**caprari**  
pumping power

caprari.com

Cod. 98062/12-06 - Copyright © 2006 Caprari S.p.A. - All Rights Reserved

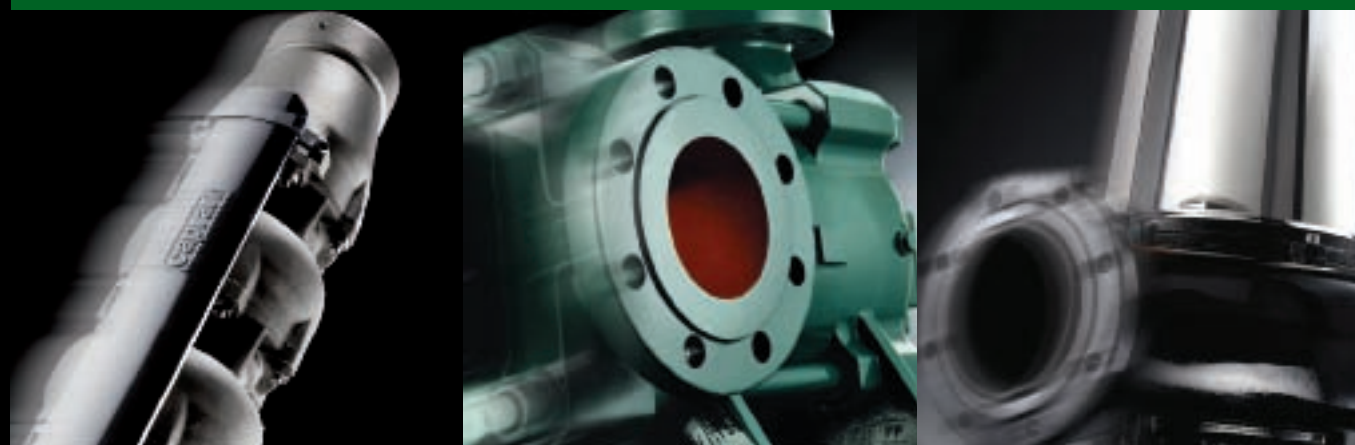

product range

**caprari**  
pumping power



at the service of **man** and the environment since 1945

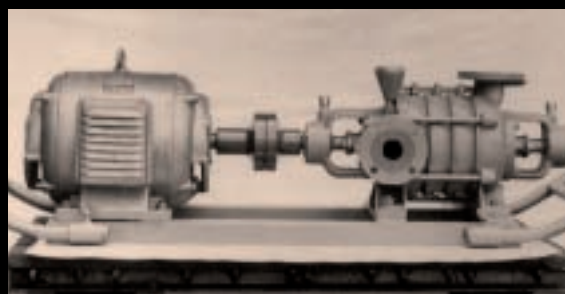

The Caprari group is a leading manufacturer on an international level in the production of centrifugal pumps and electric pumps and in the creation of advanced solutions for management of the integrated water cycle.

Founded in 1945 by Amadio Caprari, the company has continually expanded and diversified its business, to respond with innovative products and services to the specific and changing needs of the world of water with a view to an increa-

singly closer and more specialized partnership with its customers.

Thanks to its exclusive and diversified know-how, the finest and most efficient solutions for the main water requirements are now supplied: deep well pumping, waste and drainage water lifting, residential, industrial and agricultural water supply and distribution, and water treatment in general.



# passion for technology

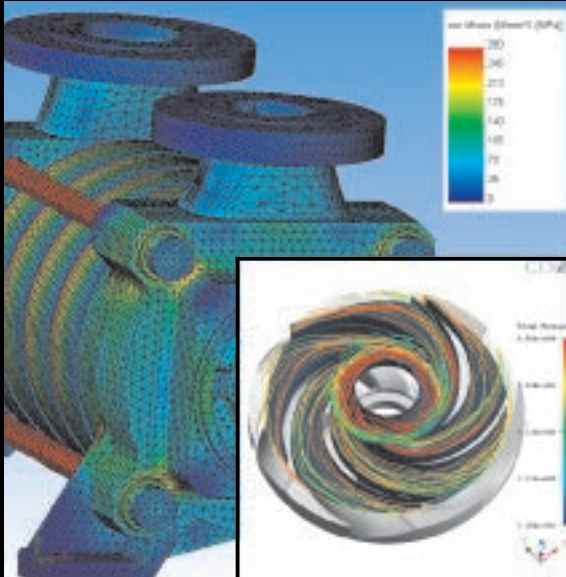

From hydraulic design using proprietary integrated programmes to complex structural analysis; from the conception of an innovative solution to severe testing in the field; from selecting the finest materials available to using the most sophisticated production technologies, the experience of many decades is combined with a daily passion.

Products with many versions to fully satisfy every specific system or use, easy installation, high efficiency and simple and cost-effective maintenance produce the best "Life Cycle Cost": the maximum efficiency of use, over the long term, so that technology gives a tangible result for people and their environment.



deep clear water



surface clear water



waste and drainage water





deep clear water

Caporali

## E4XP

### Electric stainless radial submersible pumps

Electric 4" multistage submersible pumps of the latest generation. Compact, practical and stainless, they combine power and reliability thanks to the quality of their materials and innovative design (two exclusive patents). Designed to withstand wear caused by sand and galvanic corrosion. The high hydraulic efficiencies provide tangible energy savings compared to other similar products. The dependability of the check valves and of some structural elements made of micro-cast stainless steel, together with the use of extremely high quality thermoplastic materials, moreover ensure maximum safety and durability over time. A very wide range for a choice, on every occasion, perfectly centred on actual needs.

#### technical specifications

<b>Capacity</b> up to	l/s	7
<b>Head</b> up to	m	425
<b>Power</b> up to	kW	7,5

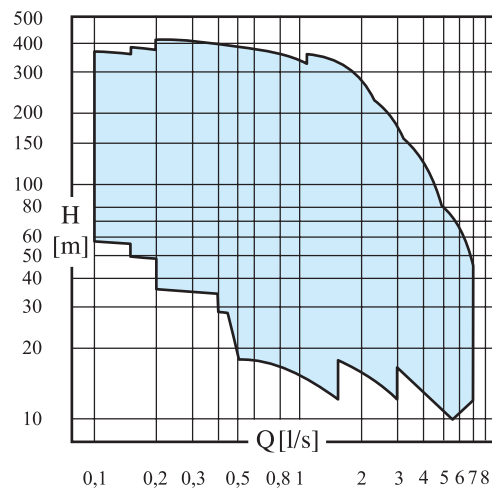

## E6X

### Electric stainless radial submersible pumps

Electric stainless 6" multistage submersible pumps.

The Caprari response to the need to combine high performance with a long life in particularly harsh working conditions. A result achieved by optimizing the advantages offered by micro-cast stainless steel and the finest thermoplastic materials for impellers and diffusers. High hydraulic efficiencies, flows and heads covering the various needs of every application sector. Extreme easyness of disassembly and riassembly, cut costs and maintenance time down to the minimum.

#### technical specifications

<b>Capacity</b> up to	l/s	12
<b>Head</b> up to	m	680
<b>Power</b> up to	kW	45

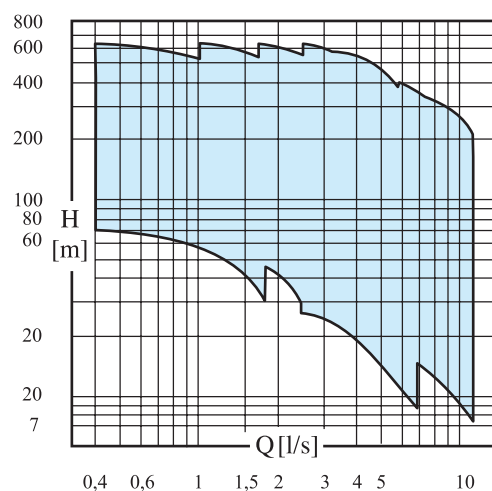

## ESX - ERX

### Stainless steel Electric mixed flow and radial submersible pumps

Electric mixed flow and radial submersible pumps made entirely of AISI 316 microcast stainless steel, including impellers and diffusers. Designed to ensure top performance in any aggressive environment, even marine. They combine compact dimensions with high performance. They are Caprari's professional response to the most heavy-duty use and most difficult working conditions. A great step forward in terms of reliability and performance compared to constructions of pressed - welded steel plate.

#### technical specifications

Capacity up to	l/s	24
Head up to	m	850
Motor power up to	kW	45

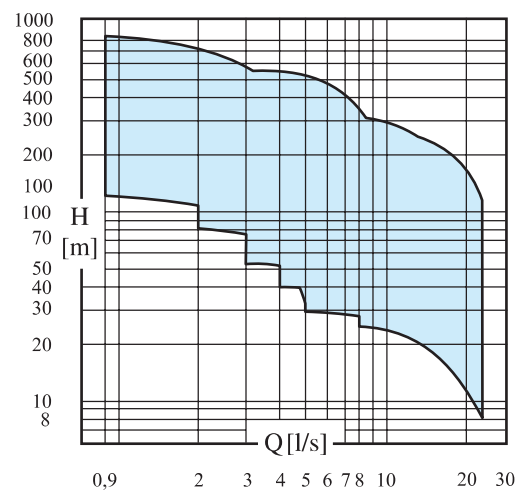

## E8R - E10R

### Electric radial submersible pumps

Electric 8" and 10" radial submersible pumps able to reach high heads. Thanks to the limited axial dimensions of the wet and these machines feature a high number of stages with limited length so as to make them compact and reliable. Especially solid machines, designed to last and to always ensure peak performance and efficiency under harsh conditions of use at great depths of installation and extremely high heads.

#### technical specifications

Capacity up to	l/s	37
Head up to	m	770
Power up to	kW	170

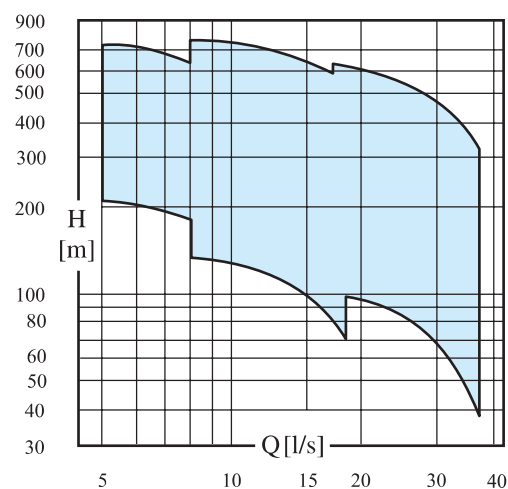



**E6S - E8S - E9S  
E10S - E12S - E14S  
E16S - E18S**  
**Electric mixed flow  
submersible pumps**

Electric mixed flow submersible pumps coupled with asynchronous submersible motors at 2.900 and 1.450 rpm. Tried and tested machines whose ideal use is for lifting medium flows and medium heads. Thousands of these Carprari pumps are installed in wells all over the world with unanimous satisfaction of the users. Sturdy construction of cast iron or bronze with impellers keyed onto the stainless steel shaft. Their design makes them especially suited for lifting water containing sand.

**technical specifications**

<b>Capacity up to</b>	l/s	250
<b>Head up to</b>	m	600
<b>Power up to</b>	kW	370

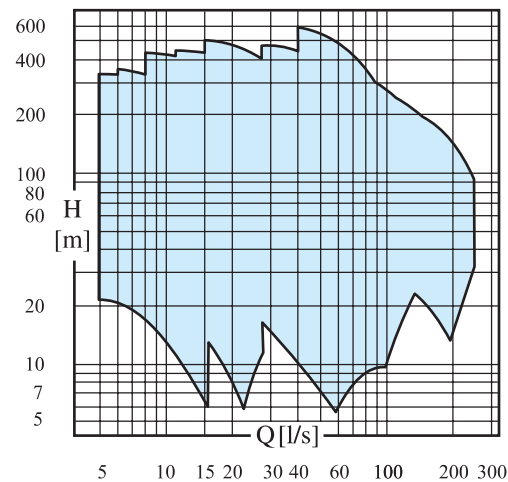

**E20S - E22S**  
**Electric mixed flow  
submersible pumps**

Electric mixed flow submersible lifting pumps that require medium-high flows.

Coupled to asynchronous submersible motors at 1.450 rpm., thanks to the low speed of rotation they ensure great reliability with low wear and a long life. Construction of cast iron or bronze with impellers keyed onto the stainless steel shaft. These electric pumps are particularly suited for continuous use in water supply, treatment systems and industrial systems in general where, besides their great reliability, energy savings play a fundamental role ensured by the excellent hydraulic efficiencies that characterise these electric pumps.

**technical specifications**

<b>Capacity up to</b>	l/s	350
<b>Head up to</b>	m	130
<b>Power up to</b>	kW	240

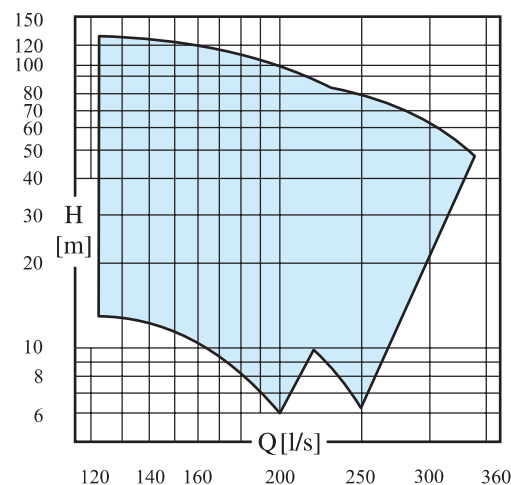

**MC4 - MCO6 - MAC6  
MC8 - MAC10 - M12  
M14**  
**Submersible motors**

Rewindable submersible single-phase and three-phase asynchronous motors expressly designed for use with "E" Series pumps. Made both in 2 and 4 poles, water or non-toxic, for perfect cooling and safe oil filled lubrication. NEMA standards for 4", 6" and 8" flanged connection. A careful study of the supports and thrust-bearing devices, using the finest materials available, is an assurance of greater reliability over time. An exclusive electrical project combined with a series of specific precautions, dictated by profound experience in the field, provide incomparable operating efficiency in both deep wells and in industrial use or water supply. Available in different construction metallurgies, they are the best solution for harsh conditions and professional systems.

**technical specifications**

<b>Poles</b>		2 and 4
<b>Frequency</b>	Hz	50 and 60
<b>Power up to</b>	kW	370



**BOOSTER SETS**

Booster sets for electric submersible pumps made of stainless steel or galvanized steel for horizontal or vertical installations, well suited not only to new systems but also to existing pipelines. Caprari's experience in making electric submersible pumps for every field of application has been applied to these niche installations and is the best guarantee for an optimal solution in terms of reliability, efficiency and cost-effective system operation. A peculiar feature of the installation of electric submersible pumps in booster sets is their silent operation. This solution is therefore recommended in lifting stations near to residential areas, as an alternative to conventional surface electric pumps.

**technical specifications**

<b>Capacity up to</b>	l/s	350
<b>Head up to</b>	m	830
<b>Power up to</b>	kW	370

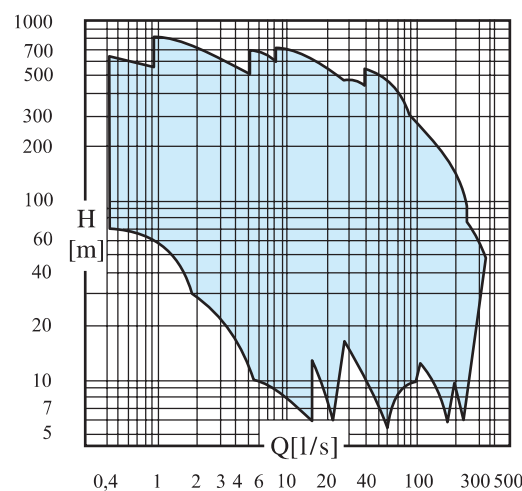

## P6 ÷ P18

### Vertical turbine pumps

Vertical lineshaft pumps with submerged pump bowl, lineshaft and drive unit on the surface, for installation in deep wells or tanks. Featuring an extremely solid and reliable construction design, they ensure great application flexibility. The technical characteristics and broad range of versions make this series ideal for pumping services in the sectors of water supply, industry, private and consortium irrigation and in fire-fighting systems. These machines can be controlled both by electric motors and by diesel engines and they ensure unequalled service efficiency.

#### technical specifications

Capacity up to	l/s	400
Head up to	m	250
Power up to	kW	400

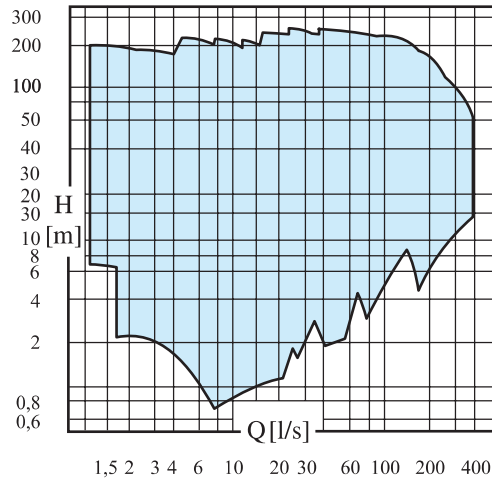



surface clear water

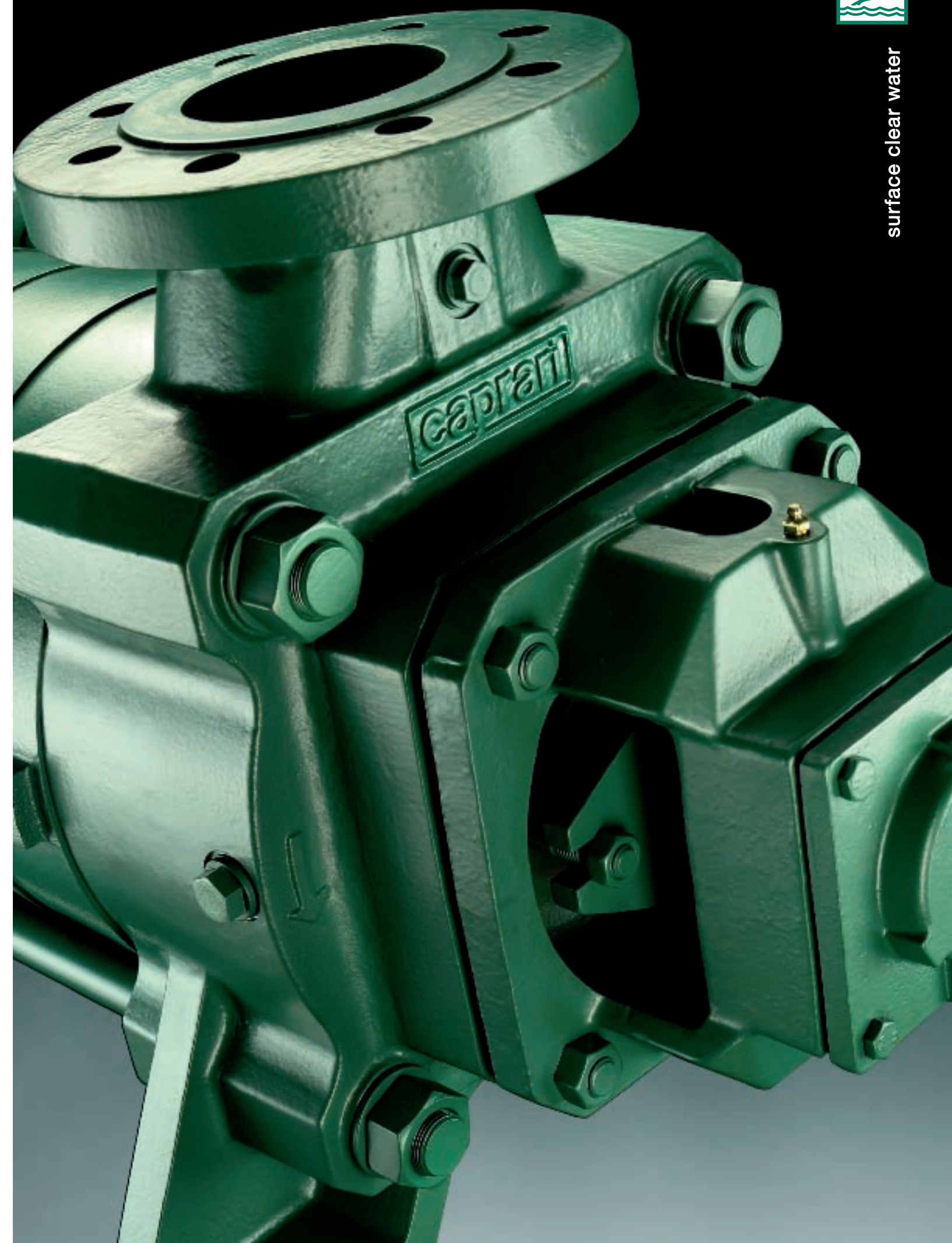

## MD

### Horizontal monobloc centrifugal electric pumps

Monobloc centrifugal electric pumps with horizontal shaft, single stage with adjustable packing or mechanical seal. Made of a sturdy cast iron structure, they are coupled with 2-pole three-phase asynchronous electric motors. Ideal for air-conditioning and cooling tower, water circulation, vessel supply, booster and irrigation systems.

#### technical specifications

Capacity up to	l/s	60
Head up to	m	85
Power up to	kW	18,5

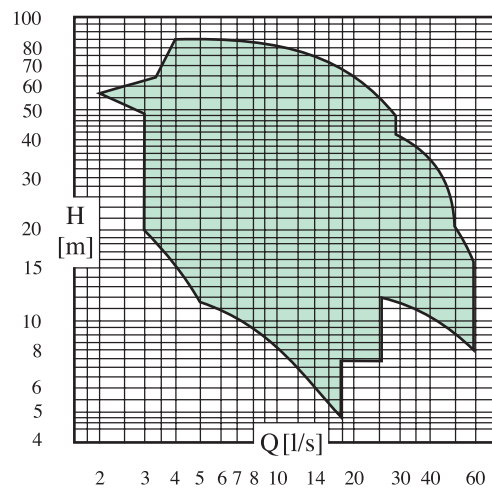

## HVX - HV

### Horizontal monobloc centrifugal electric pumps

Surface vertical multistage centrifugal electric pumps. Silent and efficient, they can be used in water supply systems, washing, fire-fighting, air-conditioning and cooling systems, in irrigation and for booster systems in general.

#### technical specifications

Capacity up to	l/s	50
Head up to	m	250
Power up to	kW	90

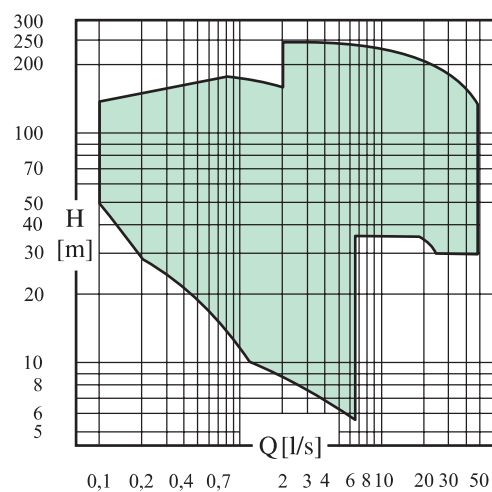

## HMU

### Horizontal centrifugal multistage pumps

Horizontal centrifugal multistage pumps. Made with cast iron hydraulic structure and copper alloy impellers, they ensure constant performance over time and the greatest economy in power consumption. Available in a wide range, they can be coupled with both electric motors and diesel engines. They can be used in different sectors such as water supply, industrial, irrigation and fire-fighting uses.

#### technical specifications

<b>Capacity</b> up to	l/s	26
<b>Head</b> up to	m	280
<b>Power</b> up to	kW	55

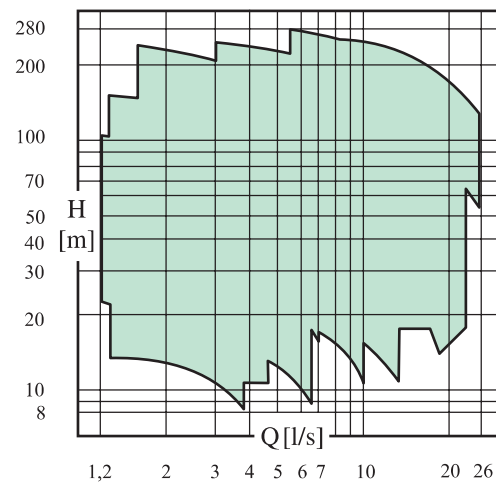

## PM

### Horizontal centrifugal multistage pumps

Centrifugal multistage pumps for high pressure. Made of special nodular, engineering cast iron for higher pressures (100 bar) and bronze. Double support with large sized bearings and hydraulic pressure balancing device. Available in versions with adjustable packing or mechanical seal. They ensure high performance and peak hydraulic efficiency. The main application sectors are: water supply, fire fighting, snow making systems, irrigation and industrial applications in general.

#### technical specifications

<b>Capacity</b> up to	l/s	160
<b>Head</b> up to	m	1000
<b>Power</b> up to	kW	650

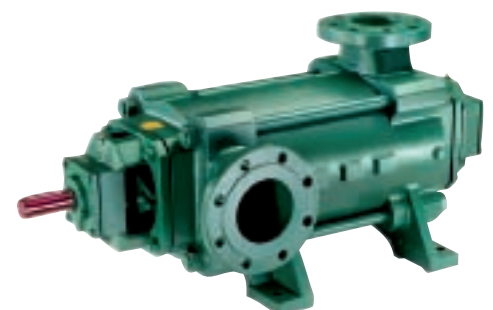
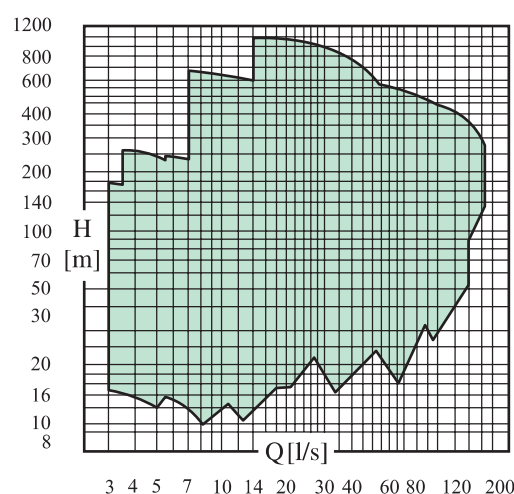

## MEC A

### Horizontal centrifugal single stage pumps

Horizontal centrifugal single stage pumps. Made with cast iron hydraulics and steel shaft. They can be coupled to both diesel engines and electric motors with 2 and 4 poles. Both packing and mechanical seals are available. A particularly versatile pump that is used in water supply, industrial, irrigation and fire-fighting applications.

#### technical specifications

Capacity up to	l/s	130
Head up to	m	140
Power up to	kW	132

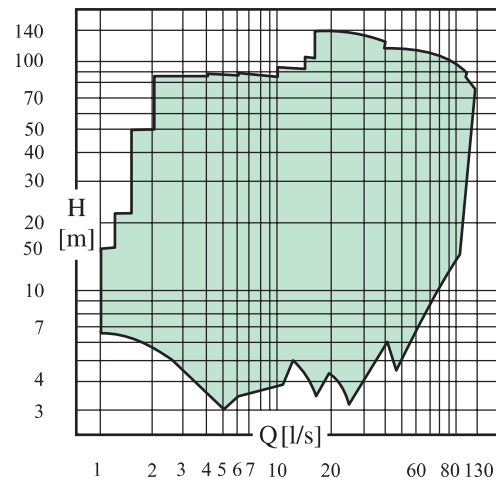

## MEC MR

### Horizontal centrifugal multistage pumps

Horizontal centrifugal multistage pumps. They can be coupled to both engines and electric motors with 2 and 4 poles. Both packing and mechanical seals are available. They are suited for use in different sectors such as water supply, industrial, irrigation and fire-fighting uses and for every requirement for raising clean water.

#### technical specifications

Capacity up to	l/s	100
Head up to	m	210
Power up to	kW	132

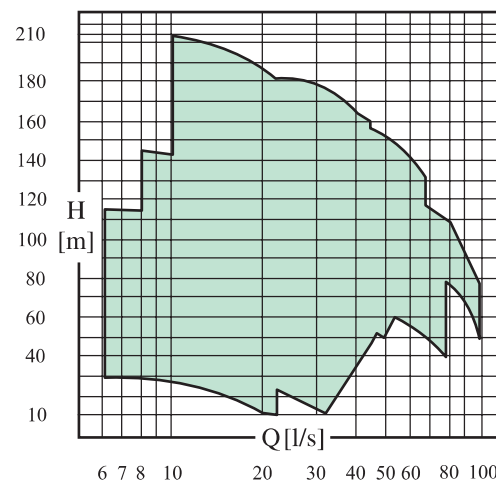

## MEC MG Flanged multistage centrifugal pumps

Horizontal centrifugal multistage pumps switabte to be flanged to diesel engines. Thanks to the compactness and sturdiness they are ideal for setting up motor pump assemblies for irrigation and fire-fighting uses.

### technical specifications

<b>Capacity</b> up to	l/s	70
<b>Head</b> up to	m	185
<b>Power</b> up to	kW	132

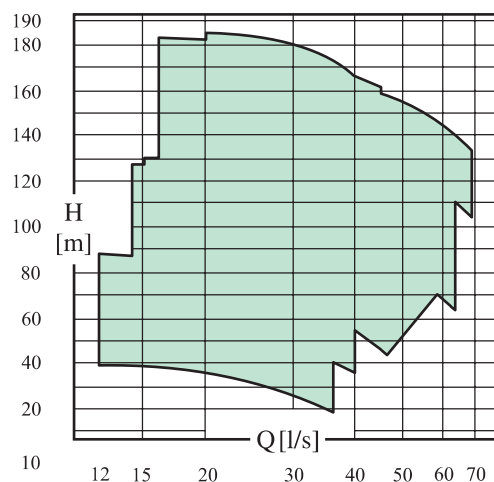

## AV Horizontal single stage centrifugal pumps

Single-stage horizontal centrifugal pumps conforming to DIN 24255/EN 733 standards. They are used in heating and air-conditioning systems in refrigerator plants, water supply, industry, irrigation and fire-fighting units. Version with mechanical seal and cast iron or bronze impeller are available.

### technical specifications

<b>Capacity</b> up to	l/s	240
<b>Head</b> up to	m	100
<b>Power</b> up to	kW	132

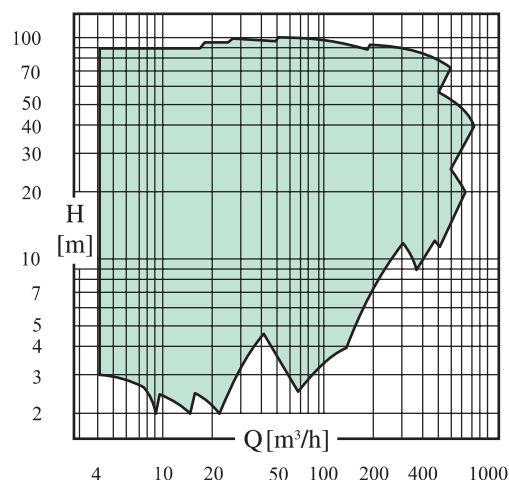



## BHR

### Horizontal single stage centrifugal pumps

Horizontal centrifugal single stage pumps. They can be coupled with both electric motors with 6 and 4 poles and with diesel engines. Pumps that deliver substantial flows find their application in irrigation, fish farming and industry in general.

#### technical specifications

Capacity up to	l/s	280
Head up to	m	25
Power up to	kW	37

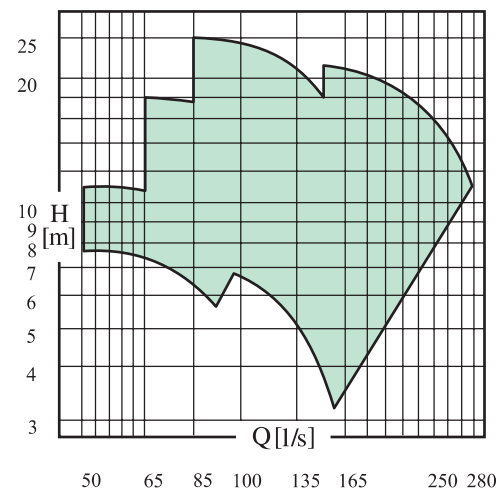

## PUMPING SET

The vast production range of single-stage and multistage pumps, the possibility of operation with an electric motor and the availability of special versions on request permit offering the optimal solutions, for each use, in terms of reliability, efficiency and operating economy.

Caprari presents pumping sets assembled with motors of first class production and high efficiencies.





waste and drainage water



## D

### Electric submersible pumps for drainage

Electric submersible pumps designed for raising drainage water, thanks to their handiness and sturdiness they are used for draining out excavations even under the harshest working conditions. Ideal for conveying clean or dirty water containing mud and sand, draining tanks and reservoirs, irrigating gardens and allotments.

#### technical specifications

Capacity up to	l/s	50
Head up to	m	40
Power up to	kW	7

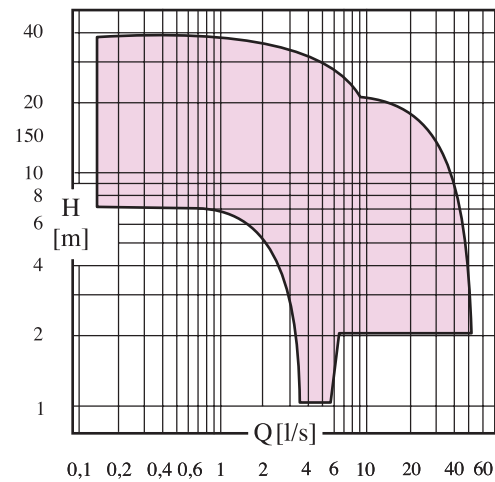

## M and MAT

### Electric submersible pumps for dirty water

Electric submersible pumps for dirty water suited for conveying sewage water with solid matter in suspension. The models in the MAT series are equipped with a shredder for residential and industrial drainage systems. Designed for high heads and small flows, they are the ideal solution to convey residential waste water in isolated areas far from the sewer mains.

#### technical specifications

Capacity up to	l/s	17
Head up to	m	34
Power up to	kW	2,2

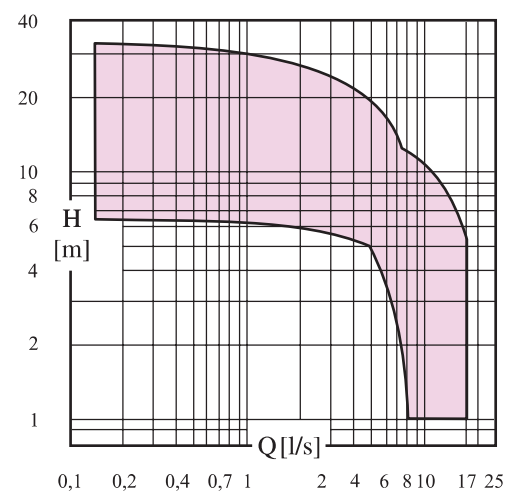

**KT+**  
**Electric submersible pumps with shredder DN 40**

Electric submersible pumps with shredder for waste water. Impellers with front clearance adjustment, hardened stainless steel shredder, high efficiency low temperature motors. Ideal for raising drainage water containing solid or fibrous matter from housing estates, single dwellings, campsites, hotels, service areas, supermarkets, farms, food preserve industries, paper industries and whenever solids in suspension must be shredded. Innovative technical solutions ensure peak hydraulic efficiency and performance with the greatest reliability. Available also in explosion. Proof version conforming to ATEX II 2G EExd IIB T4.

**technical specifications**

<b>Capacity up to</b>	l/s	4,7
<b>Head up to</b>	m	57
<b>Power up to</b>	kW	5,5

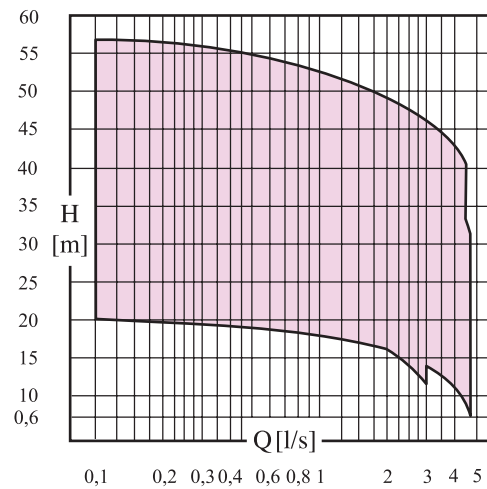

**K+**  
**Electric submersible pumps DN 65 ÷ 200**

High-efficiency electric submersible pumps for raising waste water. Expressly designed for pumping residential and industrial waste, in drainage lifting stations and water treatment plants.

Single- and double-channel hydraulics or with retracted open impeller, ideal to convey liquids with high concentrations of solids. Impellers with anti-clogging device, double mechanical seal for motor protection, oil chamber and conductivity probe. High efficiency low temperature motors, for use in a dry chamber too. A modern and professional range to ensure the best results in cutting running and maintenance costs in residential and industrial systems. Available also in explosion. Proof version conforming to ATEX II 2G EExd IIB T4.

**technical specifications**

<b>Capacity up to</b>	l/s	160
<b>Head up to</b>	m	65
<b>Power up to</b>	kW	15

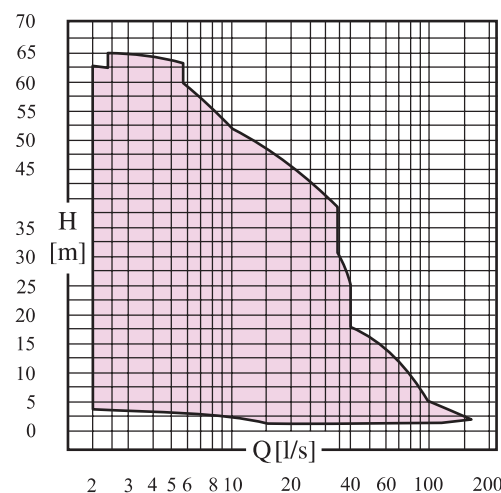

**K+**  
**Electric submersible pumps**  
**DN 100 ÷ 250**

High-efficiency electric submersible pumps for raising waste water. Expressly designed for pumping residential and industrial waste, in drainage lifting stations and treatment plants.

Single- and multi-channel hydraulics, ideal to convey liquids with high concentrations of solids. Impellers with anti-clogging device, double mechanical seal for motor protection with oil chamber and conductivity probe. High efficiency motors, also with forced cooling system for use in a dry chamber.

A modern and professional range to ensure the best results in cutting running and maintenance costs in residential and industrial treatment systems.

Available also in explosion. Proof version conforming to ATEX II 2G EExd IIB T4.

**technical specifications**

<b>Capacity</b> up to	l/s	300
<b>Head</b> up to	m	66
<b>Power</b> up to	kW	32

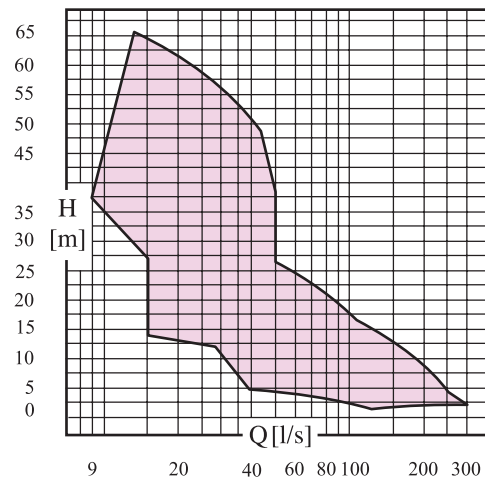

**K+**  
**Electric submersible pumps**  
**DN 150 ÷ 350**

High-efficiency electric submersible pumps for raising waste water. Expressly designed for pumping residential and industrial waste, in drainage lifting stations and treatment plants.

Single- and multi-channel hydraulics, ideal to convey liquids with high concentrations of solids. Impellers with anti-clogging device, double mechanical seal for motor protection with oil chamber and conductivity probe. High efficiency motors, also with forced cooling system for use in a dry chamber. A modern and professional range to ensure the best results in cutting running and maintenance costs in residential and industrial systems.

Available also in explosion. Proof version conforming to ATEX II 2G EExd IIB T4.

**technical specifications**

<b>Capacity</b> up to	l/s	600
<b>Head</b> up to	m	55
<b>Power</b> up to	kW	62

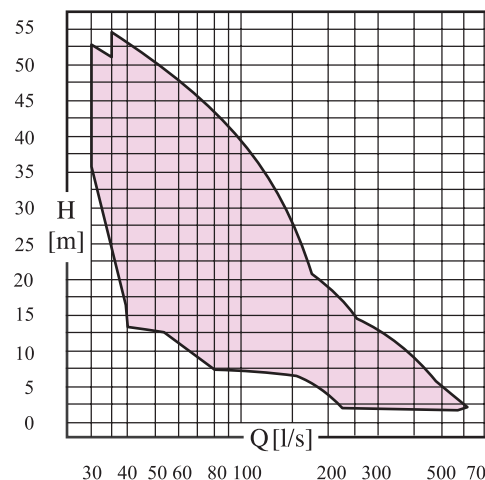

## K - KOMPACT

### Monobloc surface electric pumps for waste water

Innovative series of surface monobloc electric pumps, in horizontal or vertical version, for pumping residential and industrial waste water, coupled with standard electric motors. Compact, reliable, versatile, with easy maintenance and installation in dry chambers. Equipped with retracted vortex high-efficiency hydraulics, single-channel or double-channel impeller. Supplied as standard with double mechanical seal on the shaft, barrier oil chamber and conductivity probe. The double support for the rotor ensures excellent resistance even in the harshest industrial applications.

#### technical specifications

<b>Capacity</b> up to	l/s	300
<b>Head</b> up to	m	66
<b>Power</b> up to	kW	37

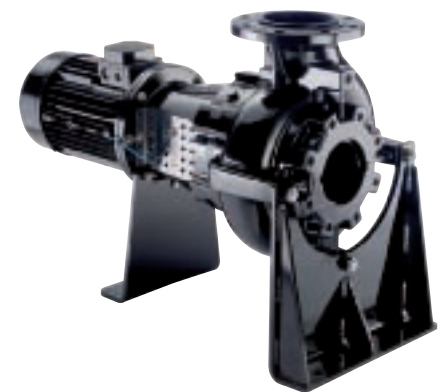
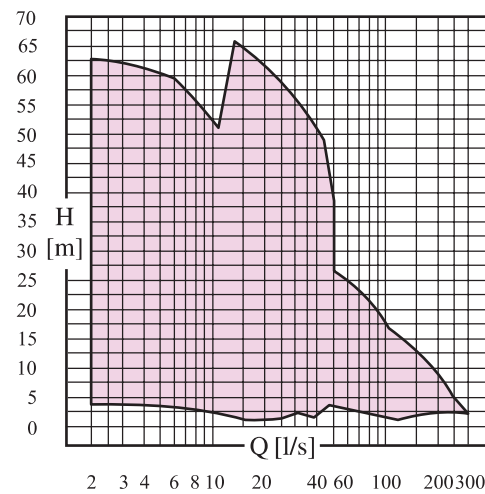

## OXY FLOW

### Aeration assembly

Aeration assembly for processes of oxygenation and homogenization in treatment plants for residential, industrial and livestock farming waste water, in fish farming and aerated ponds. Ideal for rainwater collection basins too. Compact and simple to install, they are suitable for use in tanks of any shape and size.

#### technical specifications

<b>O<sub>2</sub> output</b> up to	kg/h	280
<b>Water head</b> to	m	5,5
<b>Power</b> up to	kW	25

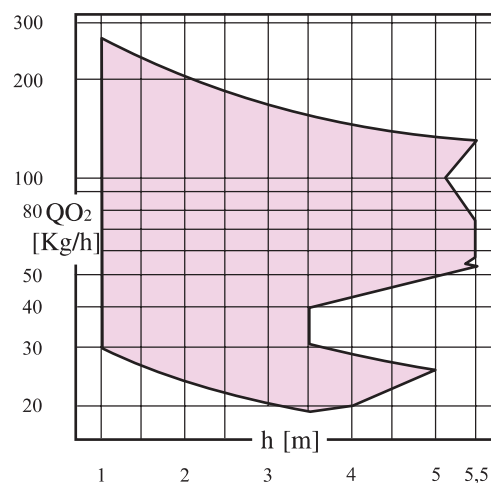

## ARS - ARS/S Radial submersible aerators

Radial submersible aerators. They are an extremely flexible system of aeration, versatile and efficient in water treatment and in all cases where mixing with the addition of air is required. The machine's compactness helps installation and maintenance without draining the tanks or stopping the systems.

### The following are available on request:

pressurized radial submersible aerators, surface aeration turbines and disc or porous pipes.

### technical specifications

<b>O<sub>2</sub> output up to</b>	kg/h	87
<b>Water head to</b>	m	6
<b>Power up to</b>	kW	51

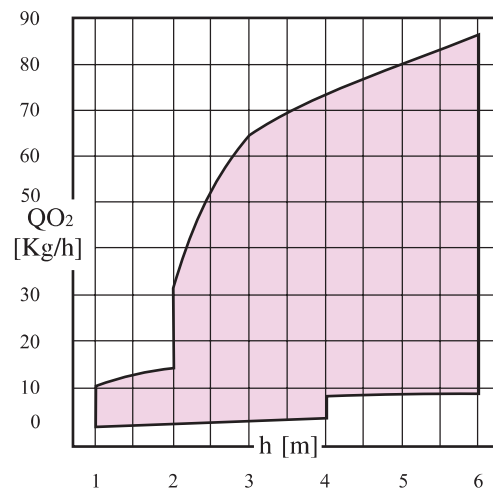

## CMVY - CMDY CMDX Horizontal submersible mixers

Horizontal submersible mixers with direct drive. For applications in nitrification/denitrification, sludge treatment and storage, disinfection tanks and industrial mixing. Available with cast-iron construction and stainless steel propeller or in totally stainless steel version - AISI 316. Galvanic separation system for standard components providing effective protection against corrosion.

### technical specifications

<b>Capacity up to</b>	l/s	316
<b>Axial thrust</b>	N	429
<b>Power up to</b>	kW	3

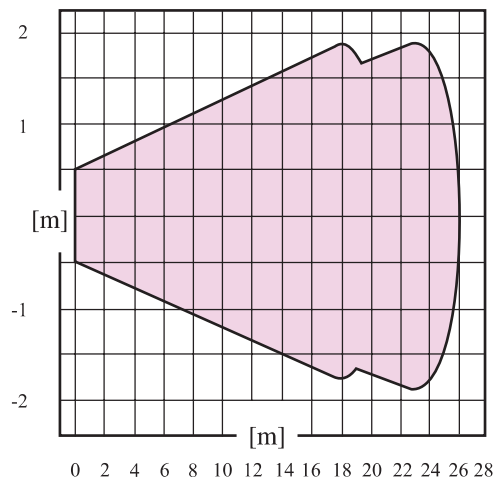

## CMRY Horizontal submersible mixers with gear

Horizontal submersible mixers with epicyclical gear between electric motor and propeller. For applications in nitrification/denitrification, sludge treatment and storage, disinfection tanks and industrial mixing. Galvanic separation system for standard components providing effective protection against corrosion.

### technical specifications

<b>Capacity</b> up to	l/s	1860
<b>Axial thrust</b>	N	3725
<b>Power</b> up to	kW	18,5

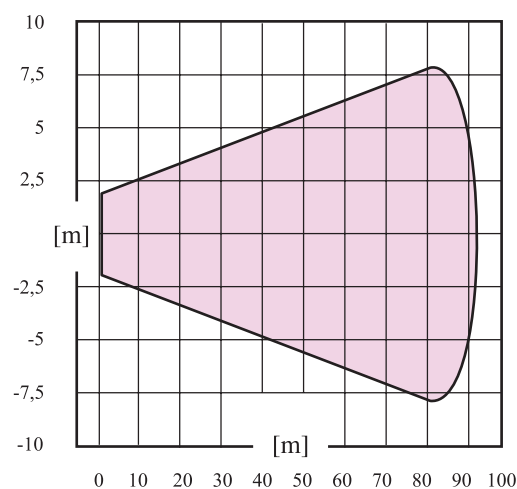

## CBAY Horizontal submersible flow accelerators

Flow accelerators for applications in nitrification/denitrification tanks, disinfection and industrial mixing. Propeller with self-cleaning blades made of a composite material with high hydraulic efficiency. Galvanic separation system for standard components providing effective protection against corrosion.

### technical specifications

<b>Capacity</b> up to	l/s	4890
<b>Axial thrust</b>	N	2900
<b>Power</b> up to	kW	4

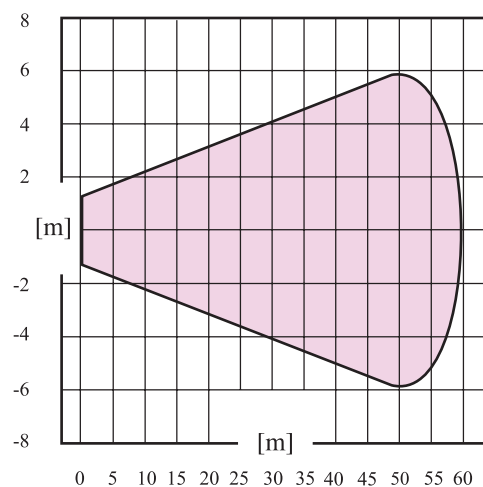



**Caprari SpA**

Via Emilia Ovest, 900  
41100 Modena (Italy)

Logistic Area  
Via Guido Cavani 220  
41100 Modena (Italy)

Tel. +39 059 897611  
Fax +39 059 897897  
www.caprari.com  
e-mail: info@caprari.it

**Milano**

Via Santa Rita da Cascia, 33  
20143 Milano  
Tel. +39 02 8138800  
Fax +39 02 8139451  
e-mail: filiale.milano@caprari.it

**Roma**

Viale Pasteur, 65  
00144 Roma  
Tel. +39 06 5913541  
Fax +39 06 54210617  
e-mail: filiale.roma@caprari.it

**Caprari France SARL**

16 Rue Claude Bernard - Z.A. Pariwest  
78310 Maurepas - Paris (France)  
Tel. +33 1 30139270  
Fax +33 1 30139276  
www.caprarifrance.fr  
e-mail: caprari@caprarifrance.fr

**Bombas Caprari SA**

C/Federico Chueca 5 - Polig. Ind. Santa Rosa  
28806 Alcalá de Henares - Madrid (España)  
Tel. +34 91 8887653  
Fax +34 91 8880326  
www.bombascaprari.es  
e-mail: info@bombascaprari.es

**Caprari Portugal LDA**

Rua Do Matadouro Regional - Lote 46  
Zona Industrial  
2005-002 Santarém (Portugal)  
Tel. +351 243 350610  
Fax +351 243 350619  
www.caprari.com  
e-mail: geral@caprariportugal.pt

**Caprari Pumps (UK) LTD**

Caprari House - Bakewell Road - Orton Southgate  
Peterborough PE2 6XU (United Kingdom)  
Tel. +44 1733 371605  
Fax +44 1733 371607  
www.caprari.co.uk  
e-mail: info@caprari.co.uk

**Caprari Pumpen GmbH**

Kleemanngasse 15  
D-90765 Fürth - Bayern (Germany)  
Tel. +49 911 610930  
Fax +49 911 6109349  
www.caprari.de  
e-mail: caprari@caprari.de

**Caprari Pumps Australia PTY LTD**

3 Jeans Street  
Beverley SA - 5009 (Australia)  
Box 159 Woodville SA - 5011  
Tel. +61 8 8244 4442  
Fax +61 8 8244 4462  
www.caprari.com  
e-mail: sales@caprari.com.au

**Caprari Hellas SA**

Industrial Area of Sindos  
Municipality of Ehedorou  
57022 Thessaloniki (Greece)  
Tel. +30 2310 797967  
Fax +30 2310 797968  
www.caprari.gr  
e-mail: info@caprari.gr

**Caprari Pumps Yemen LTD**

Head Office - North Rawdha  
P.O. Box: 2145 Sana'a  
(Republic of Yemen)  
Tel. +967 1 344631/344632  
Fax +967 1 344633  
www.caprari.com

**S.M. Baghanem & Saudi**

**Caprari Pumps Factory LTD**  
Jeddah Industrial Area - P.O. Box: 181216  
King Fahd Street - Al Kandarrah  
21415 Jeddah (Kingdom of Saudi Arabia)  
Tel. +966 2 6081434/6436275  
Fax +966 2 6439258  
www.caprari.com

**SWM SpA**

Via Mantegna 6  
42048 Rubiera - Reggio Emilia (Italy)  
Tel. +39 0522 629041  
Fax +39 0522 628970  
www.caprari.com  
e-mail: info@swmmotori.it

**Fondmatic SpA**

Via Degli Orsi 518  
40014 Crevalcore - Bologna (Italy)  
Tel. +39 051 982567  
Fax +39 051 983287  
www.fondmatic.it  
e-mail: fondmatic@fondmatic.it

**caprari**  
pumping power



COMPANY  
WITH QUALITY SYSTEM  
CERTIFIED BY DNV  
ISO 9001/2000

Sewage electric pumps  
according to explosion proof  
ATEX II 2G EExd IIB T4